



General Description

The SiI 141 uses PanelLink Digital technology to support displays ranging from VGA to High Refresh XGA (25-86 MHz), which is ideal for LCD desktop monitor applications. With a flexible single or dual pixel out interface and selectable output drive, the SiI 141 receiver supports up to true color panels (24 bit/pixel, 16.7M colors) in 1 pixel/clock mode (18 bit/pixel in 2 pixel/clock mode). PanelLink also features an inter-pair skew tolerance up to 1 full input clock cycle and a highly jitter tolerant PLL design. Since all PanelLink products are designed on scaleable CMOS architecture to support future performance requirements while maintaining the same logical interface, system designers can be assured that the interface will be fixed through a number of technology and performance generations.

PanelLink Digital technology simplifies PC design by resolving many of the system level issues associated with high-speed digital design, providing the system designer with a digital interface solution that is quicker to market and lower in cost.

Features

- Scaleable Bandwidth: 25-86 MHz (VGA to High Refresh XGA)
- Low Power: 3.3V core operation & power-down mode
- High Skew Tolerance: 1 full input clock cycle (15ns at 65 MHz)
- Pin-compatible with SiI101
- Sync Detect: for Plug & Display "Hot Plugging"
- Cable Distance Support: over 5m with twisted-pair, fiber-optics ready
- Compliant with DVI 1.0 (DVI is backwards compatible with VESA® P&D™ and DFP)

SiI141 Pin Diagram

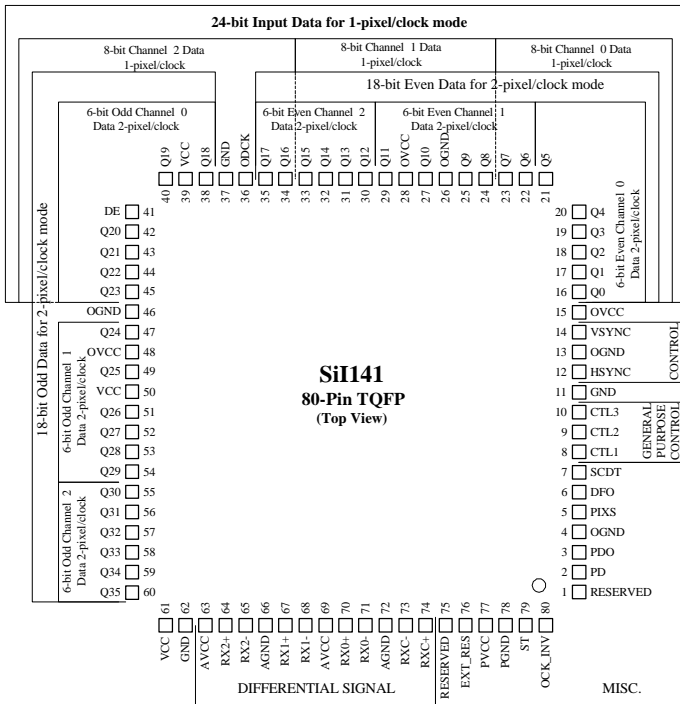

Functional Block Diagram

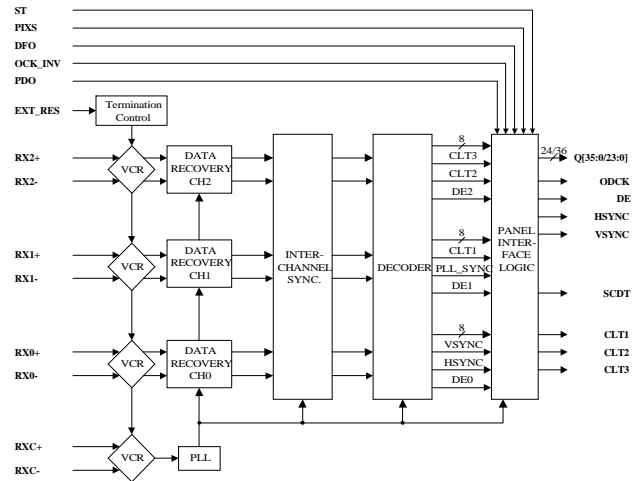

Absolute Maximum Conditions

Note: Permanent device damage may occur if absolute maximum conditions are exceeded.
Functional operation should be restricted to the conditions described under Normal Operating Conditions.

Symbol	Parameter	Min	Max	Units
V _{CC}	Supply Voltage 3.3V	-0.3	4.0	V
V _I	Input Voltage	-0.3	V _{CC} + 0.3	V
V _O	Output Voltage	-0.3	V _{CC} + 0.3	V
T _A	Ambient Temperature (with power applied)	-25	105	°C
T _{STG}	Storage Temperature	-40	125	°C
P _{PD}	Package Power Dissipation		1	W

Normal Operating Conditions

Symbol	Parameter	Min	Typ	Max	Units
V _{CC}	Supply Voltage	3.00	3.3	3.6	V
V _{CCN}	Supply Voltage Noise			100	mV _{P-P}
T _A	Ambient Temperature (with power applied)	0	25	70	°C

Note: ¹ Guaranteed by design.

DC Digital I/O Specifications

Under normal operating conditions unless otherwise specified.

Symbol	Parameter	Conditions	Min	Typ	Max	Units
V _{IH}	High-level Input Voltage		2			V
V _{IL}	Low-level Input Voltage				0.8	V
V _{OH}	High-level Output Voltage		2.4			V
V _{OL}	Low-level Output Voltage				0.4	V
V _{CINL}	Input Clamp Voltage ¹	I _{CL} = -18mA			GND -0.8	V
V _{C IPL}	Input Clamp Voltage ¹	I _{CL} = 18mA			IVCC + 0.8	V
V _{CONL}	Output Clamp Voltage ¹	I _{CL} = -18mA			GND -0.8	V
V _{COPL}	Output Clamp Voltage ¹	I _{CL} = 18mA			OVCC + 0.8	V
I _{IL}	Input Leakage Current		-10		10	μA

Note: ¹ Guaranteed by design.

DC Specifications

Under normal operating conditions unless otherwise specified. Low drive strength values, when ST=0, are shown in brackets.

Symbol	Parameter	Conditions	Min	Typ	Max	Units
I _{OHD}	Output High Drive Data and Controls	V _{OUT} = V _{OH} ST=1 ST=0	5.0 2.51	10.3 5.15	17.6 8.8	mA
I _{OLD}	Output Low Drive Data and Controls	V _{OUT} = V _{OL} ST=1 ST=0	-5.5 -2.8	-8.3 -4.2	-11.2 -5.6	mA
I _{OHC}	ODCK High Drive	V _{OUT} = V _{OH} ST=1 ST=0	10.1 5.0	20.6 10.3	35.1 17.6	mA
I _{OLC}	ODCK Low Drive	V _{OUT} = V _{OL} ST=1 ST=0	-11.1 -5.5	-16.7 -8.3	-22.4 -11.2	mA
V _{ID}	Differential Input Voltage Single Ended Amplitude		75		1000	mV
I _{PD}	Power-down Current ¹				25	μA
I _{PDL}	Output leakage current to ground in high impedance mode (PD, PDO = LOW)				10	uA
I _{CCR}	Receiver Supply Current DCLK=86MHz, 1-pixel/clock mode ²	C _{LOAD} = 10pF R _{EXT_SWING} = 680 Ω Typical Pattern ³		157	182	mA
	DCLK=86MHz, 1-pixel/clock mode ²	C _{LOAD} = 10pF R _{EXT_SWING} = 680 Ω Worst Case Pattern ⁴		172	194	mA

Notes: ¹ The transmitter must be in power-down mode, powered off, or disconnected for the current to be under this maximum.

² For worst case I/O power consumption.

³ The Typical Pattern contains a gray scale area, checkerboard area, and text.

⁴ Black and white checkerboard pattern, each checker is one pixel wide.

AC Specifications

Under normal operating conditions unless otherwise specified. Low drive strength values, when ST=0, are given below.

Symbol	Parameter	Conditions	Min	Typ	Max	Units
T _{DPS}	Intra-Pair (+ to -) Differential Input Skew	86 MHz One pixel / clock			470	ps
T _{CCS}	Channel to Channel Differential Input Skew	86 MHz One pixel / clock			7	ns
T _{IJT}	Worst Case Differential Input Clock Jitter tolerance ^{1,2} 65 MHz, One Pixel / Clock				465	ps
					350	ps
D _{LHT}	Low-to-High Transition Time: Data and Controls	C _L = 10pF, ST=1			5.2	ns
		C _L = 5pF, ST=0			4.4	
D _{HLT}	High-to-Low Transition Time: Data and Controls	C _L = 10pF, ST=1			2.3	ns
		C _L = 5pF, ST=0			1.8	
D _{HLT}	High-to-Low Transition Time: Data and Controls	C _L = 10pF, ST=1			3.8	ns
		C _L = 5pF, ST=0			3	
T _{SOF}	Data/Control Setup Time to ODCK falling ⁴ (OCK_INV=0): 65 MHz, One Pixel / Clock, PIXS = 0	C _L = 10pF, ST=1	2			ns
		C _L = 5pF, ST=0	1.6			
T _{HOFF}	Data/Control Hold Time to ODCK falling ⁴ (OCK_INV=0): 65 MHz, One Pixel / Clock, PIXS = 0	C _L = 10pF, ST=1	5			ns
		C _L = 5pF, ST=0	5			
T _{HOFF}	Data/Control Hold Time to ODCK falling ⁴ (OCK_INV=0): 43 MHz, Two Pixel / Clock, PIXS = 1	C _L = 10pF, ST=1	6			ns
		C _L = 5pF, ST=0	6			
R _{CIP}	ODCK Cycle Time (1 pixel/clock)		11.6		50	ns
F _{CIP}	ODCK Frequency (1 pixel/clock)		20		86	MHz
R _{CIP}	ODCK Cycle Time (2 pixels/clock)		23.3		100	ns
F _{CIP}	ODCK Frequency (2 pixels/clock)		10		43	MHz
R _{CIH}	ODCK High Time 65 MHz, One Pixel / Clock, PIXS = 0 ³	C _L = 10pF, ST=1	5			ns
		C _L = 5pF, ST=0	4.4			
R _{CIH}	43 MHz, Two Pixel / Clock, PIXS = 1 ³	C _L = 10pF, ST=1	9			ns
		C _L = 5pF, ST=0	8.2			
R _{CIL}	ODCK Low Time 65 MHz, One Pixel / Clock, PIXS = 0 ³	C _L = 10pF, ST=1	6			ns
		C _L = 5pF, ST=0	5			
R _{CIL}	43 MHz, Two Pixel / Clock, PIXS = 1 ³	C _L = 10pF, ST=1	9			ns
		C _L = 5pF, ST=0	9			
T _{HSC}	Link disabled (DE inactive) to SCDT low ¹			160		ms
	Link disabled (Tx power down) to SCDT low ⁵			200	250	ms
T _{FSC}	Link enabled (DE active) to SCDT high				40	Falling DE edges
T _{PDL}	Delay from PD/ PDO Low to high impedance outputs				8	ns

Notes: ¹ Jitter defined as per DVI 1.0 Specification, Section 4.6 *Jitter Specification*.

² Jitter measured with Clock Recovery Unit as per DVI 1.0 Specification, Section 4.7 *Electrical Measurement Procedures*.

³ Output clock duty cycle is independent of the differential input clock duty cycle and the IDCK duty cycle.

⁴ The setup and hold timing for the data and controls relative to the ODCK rising edge (OCK_INV=1) is by design the same as the falling edge timing.

⁵ Measured when transmitter was powered down (see SiI/AN-0005 "PanelLink Basic Design /Application Guide," Section 2.4).

Timing Diagrams

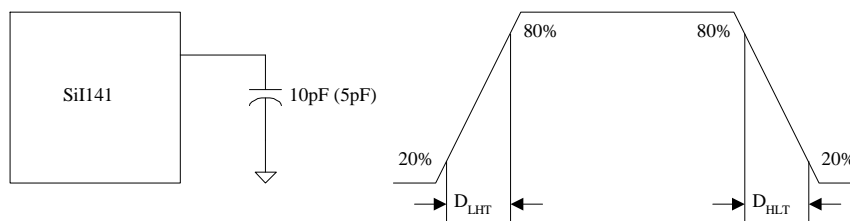

Figure 1. Digital Output Transition Times

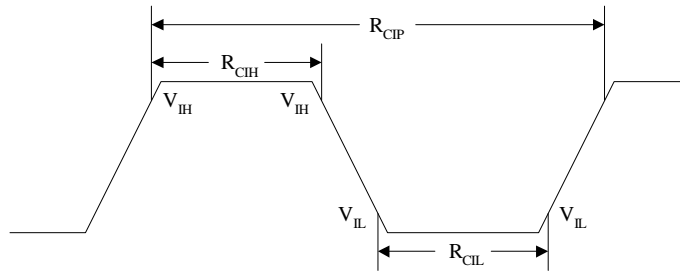

Figure 2. Receiver Clock Cycle/High/Low Times

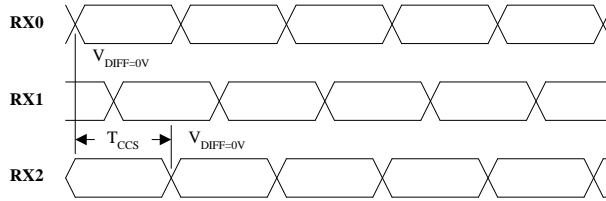

Figure 3. Channel-to-Channel Skew Timing

Output Timing

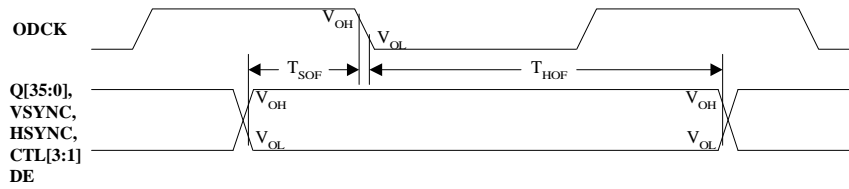

Figure 4. Output Data Setup/Hold Times to ODCK

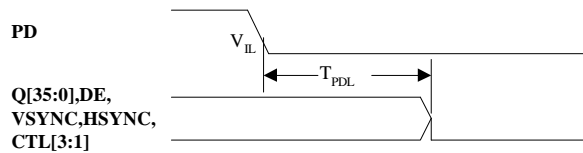

Figure 5. Output Signals Disabled Timing from PD Active

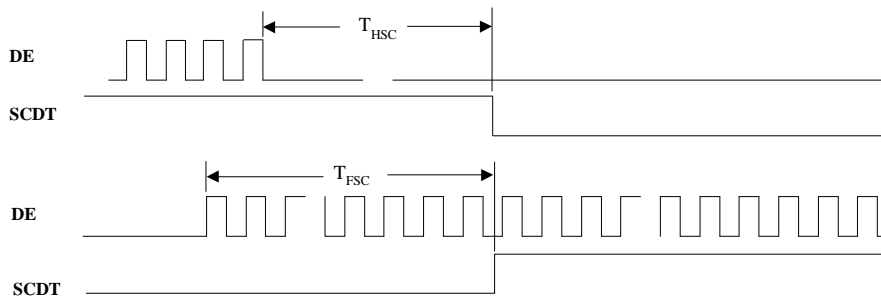

Figure 6. SCDT Timing from DE Inactive/Active

Output Pin Description

Pin Name	Pin #	Type	Description
Q35 – Q0	See SiI141 Pin Diagram	Out	Output Data [35:0].
			Output data is synchronized with output data clock (ODCK).
			When PIXS is low Q35-Q24 are low and Q23-Q0 output 24-bit/pixel data.
			When PIXS is high Q17-Q0 output the even numbered pixels (pixel 0, 2, 4, ... , etc.) and Q35-Q18 output the odd numbered pixels (pixel 1, 3, 5, ... , etc.).
			Refer to the TFT Signal Mapping (SiI/AN-0008) and DSTN Signal Mapping (SiI/AN-0007) application notes which tabulate the relationship between the input data to the transmitter and output data from the receiver.
			A low level on PD or PDO will put the output drivers into a high impedance (tri-state) mode. A weak internal pull-down device brings each output to ground.
ODCK	36	Out	Output Data Clock. A low level on PD or PDO will put the output drivers into a high impedance (tri-state) mode. A weak internal pull-down device brings each output to ground.
DE	41	Out	Output Data Enable. A low level on PD or PDO will put the output drivers into a high impedance (tri-state) mode. A weak internal pull-down device brings each output to ground.
HSYNC	12	Out	Horizontal Sync output control signal.
VSYNC	14	Out	Vertical Sync output control signal.
CTL1	8	Out	General output control signal 1. This pin is not controlled by PDO.
CTL2	9	Out	General output control signal 2.
CTL3	10	Out	General output control signal 3.
			A low level on PD or PDO will put the output drivers into a high impedance (tri-state) mode. A weak internal pull-down device brings each output to ground.

Configuration Pin Description

Pin Name	Pin #	Type	Description
OCK_INV	80	In	ODCK Polarity. A low level selects normal ODCK output, which enables data latching on the falling edge. A high level (3.3V) selects inverted ODCK output, which enables data latching on the rising edge. Both conditions are for color TFT panel support. For color 24-bit DSTN panel support, please refer to the DSTN Signal Mapping (SiI/AN-0008-A) application note.
PIXS	5	In	Pixel Select. A low level indicates that output data is one pixel (up to 24-bit) per clock and a high level (3.3V) indicates that output data is two pixels (up to 36-bit) per clock.
DF0	6	In	Output Data Format. This pin controls clock and data output format. A low level indicates that ODCK runs continuously for color TFT panel support and a high level (3.3V) indicates that ODCK is stopped (LOW) for color 24-bit DSTN panel support when DE is low. Refer to the TFT Signal Mapping (SiI/AN-0007-A) and DSTN Signal Mapping (SiI/AN-0008-A) application notes for a table on TFT or DSTN panel support.
ST	79	In	Output Driver Strength. A low level indicates low drive. A high level indicates high drive.

Power Management Pin Description

Pin Name	Pin #	Type	Description
SCDT	7	Out	SyncDetect. A high level is output when DE is toggling. A low level is output when DE is inactive.
PD	2	In	Power Down (active low). A high level (3.3V) indicates normal operation and a low level indicates power down mode. During power down mode all internal circuitry is powered down and digital I/O are set the same as when PDO is asserted. (see PDO pin description).
PDO	3	In	Power Down Output (active low). A high level indicates normal operation. A low level puts the output drivers only into a high impedance (tri-state) mode. A weak internal pull-down device brings each output to ground. There is an internal pull-up resistor on PDO that defaults the chip to normal operation if left unconnected. SCDT and CTL1 are not tri-stated by this pin.

Differential Signal Data Pin Description

Pin Name	Pin #	Type	Description
RX0+	70	Analog	TMDS Low Voltage Differential Signal input data pairs.
RX0-	71		
RX1+	67		
RX1-	68		
RX2+	64		
RX2-	65		
RXC+	74	Analog	TMDS Low Voltage Differential Signal input clock pair.
RXC-	73		
EXT_RES	76	Analog	Impedance Matching Control. Resistor value should be ten times the characteristic impedance of the cable. In the common case of 50Ω transmission line, an external 500Ω resistor must be connected between AVCC and this pin.

Reserved Pin Description

Pin Name	Pin #	Type	Description
RSVD	1	Out	This signal must be left unconnected.
RSVD	75	In	This pin must be tied high.

Power and Ground Pin Description

Pin Name	Pin #	Type	Description
VCC	39	Power	Core VCC, must be set to 3.3V.
	50		
	61		
GND	11	Ground	Digital GND.
	37		
	62		
OVCC	15	Power	Output VCC, must be set to 3.3V.
	28		
	48		
OGND	4	Ground	Output GND.
	13		
	26		
	46		
AVCC	63	Power	Analog VCC, must be set to 3.3V.
	69		
AGND	66	Ground	Analog GND.
	72		
PVCC	77	Power	PLL VCC, must be set to 3.3V.
PGND	78	Ground	PLL GND.

Application Information

To obtain the most updated Application Notes and other useful information for your design application, please visit the Silicon Image web site at www.siimage.com, or contact your local Silicon Image sales office.

Ordering Information

Part Number: SiI141CT80

Package Dimensions

80-pin TQFP Package Dimensions

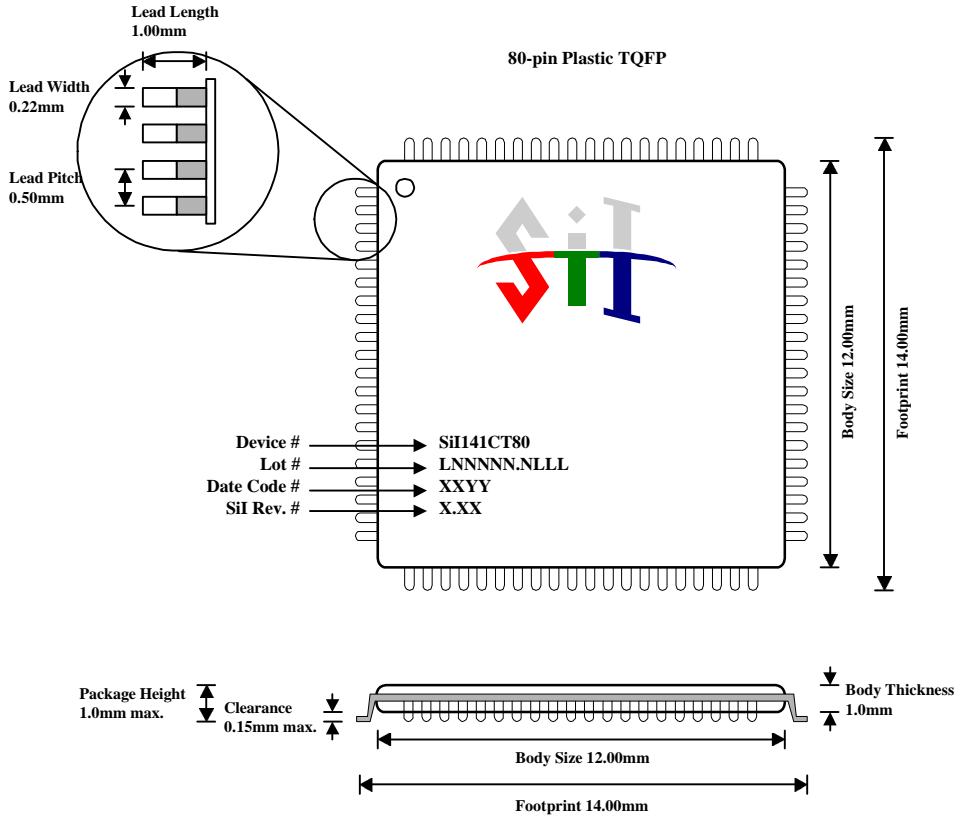

Copyright Notice

This manual is copyrighted by Silicon Image, Inc. Do not reproduce, transform to any other format, or send/transmit any part of this documentation without the express written permission of Silicon Image, Inc.

Trademark Acknowledgment

PanelLink and the PanelLink Digital logo are registered trademarks of Silicon Image, Inc. Silicon Image, the Silicon Image logo and TMDS are trademarks of Silicon Image, Inc. VESA is a registered trademark of Video Electronics Standards Association. TMDS is a licensed trademark of VESA. All other trademarks are the property of their respective holders.

Disclaimer

This document provides technical information for the user. Silicon Image, Inc. reserves the right to modify the information in this document as necessary. The customer should make sure that they have the most recent data sheet version. Silicon Image, Inc. holds no responsibility for any errors that may appear in this document. Customers should take appropriate action to ensure their use of the products does not infringe upon any patents. Silicon Image, Inc. respects valid patent rights of third parties and does not infringe upon or assist others to infringe upon such rights.

Ordering Information

Part Number: SiI141CT80

© 1999 Silicon Image, Inc. 7/99 SiI/DS-0004-D

Silicon Image, Inc.
 10131 Bubb Road
 Cupertino, CA 95014
 USA

Tel: 408-873-3111
Fax: 408-873-0446
E-Mail: salesupport@siimage.com
Web: www.siimage.com
www.panellink.com

